

This article was downloaded by:

On: 26 January 2011

Access details: *Access Details: Free Access*

Publisher *Taylor & Francis*

Informa Ltd Registered in England and Wales Registered Number: 1072954 Registered office: Mortimer House, 37-41 Mortimer Street, London W1T 3JH, UK



## Liquid Crystals

Publication details, including instructions for authors and subscription information:

<http://www.informaworld.com/smpp/title~content=t713926090>

### **A study of some lyotropic cholesteric mesophases by circular and linear dichroism and by circular intensity differential scattering**

Gian Piero Spada<sup>a</sup>; Giovanni Gottarelli<sup>a</sup>; Bruno Samori<sup>a</sup>; Carlos J. Bustamante<sup>b</sup>; K. Sam Wells<sup>b</sup>

<sup>a</sup> Dipartimento di Chimica Organica, Universita' di Bologna, Bologna, Italy <sup>b</sup> Chemistry Department, University of New Mexico, Albuquerque, New Mexico, U.S.A.

**To cite this Article** Spada, Gian Piero , Gottarelli, Giovanni , Samori, Bruno , Bustamante, Carlos J. and Wells, K. Sam(1988) 'A study of some lyotropic cholesteric mesophases by circular and linear dichroism and by circular intensity differential scattering', *Liquid Crystals*, 3: 1, 101 – 113

**To link to this Article:** DOI: 10.1080/02678298808086353

**URL:** <http://dx.doi.org/10.1080/02678298808086353>

PLEASE SCROLL DOWN FOR ARTICLE

Full terms and conditions of use: <http://www.informaworld.com/terms-and-conditions-of-access.pdf>

This article may be used for research, teaching and private study purposes. Any substantial or systematic reproduction, re-distribution, re-selling, loan or sub-licensing, systematic supply or distribution in any form to anyone is expressly forbidden.

The publisher does not give any warranty express or implied or make any representation that the contents will be complete or accurate or up to date. The accuracy of any instructions, formulae and drug doses should be independently verified with primary sources. The publisher shall not be liable for any loss, actions, claims, proceedings, demand or costs or damages whatsoever or howsoever caused arising directly or indirectly in connection with or arising out of the use of this material.

## **A study of some lyotropic cholesteric mesophases by circular and linear dichroism and by circular intensity differential scattering**

by GIAN PIERO SPADA, GIOVANNI GOTTARELLI, and  
BRUNO SAMORI'

Dipartimento di Chimica Organica, Università' di Bologna, Via S. Donato, 15,  
40127 Bologna, Italy

CARLOS J. BUSTAMANTE and K. SAM WELLS

Chemistry Department, University of New Mexico, Albuquerque, New Mexico  
87131, U.S.A.

*(Received 19 May 1987; accepted 27 August 1987)*

The handedness of lyotropic cholesterics formed by decylammonium chloride, ammonium chloride, water and chiral dopants was determined by circular and linear dichroism and, independently, by circular intensity differential scattering. From the study of the twisting power of a few dopants and from the magnetic orientation of cholesterics with long and short pitches, it is concluded that distortion of the micelles is likely to be determinant for the formation of the cholesteric phase.

### **1. Introduction**

The study of the cholesteric mesophases induced in thermotropic nematics by chiral dopants has led to relevant information about the stereochemistry of the dopants [1] and the mechanism of the cholesteric induction [2]. Induced cholesteric solutions also afford a sensitive method to detect traces of chiral substances [3] and to characterize molecules with very low optical rotation [4].

Lyotropic nematics are formed by mixtures of amphiphiles and water [5]. The building units in lyotropics are anisometric micelles. Recent X-ray and neutron scattering studies suggest that these micelles are weakly anisometric: oblate spheroids of disk-like shape or prolate spheroids of rod-like shape, depending on composition and temperature [6]. Formation of lyotropic cholesteric structures can be induced by the addition of chiral solutes to the nematic phase [7].

It seems natural, therefore, to investigate the structural properties of cholesteric lyotropics in the light of those known for cholesteric thermotropic liquid crystals. Lyotropic solvents could be particularly interesting for chiral biomolecules which are insoluble in organic solvents. The lyotropic nematic phase formed by decylammonium chloride (DACl), ammonium chloride and water [7, 8] is a convenient solvent for this purpose. This liquid crystal may be labelled as  $N_D$  because of the disk-like shape of its micelles and the tendency of their symmetry axes to align perpendicular to an orienting magnetic field. The diamagnetic susceptibility of this nematic phase is in fact negative. This means that fingerprint textures, necessary for measuring the pitch, can be obtained without unwinding the cholesteric. In addition the planar textures needed

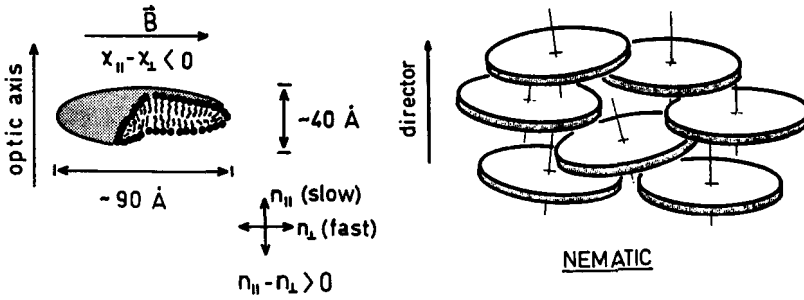

Figure 1. Anisotropic characteristics of DACI micelles.

for optical measurements can be obtained easily [7]. The sign of the optical anisotropy has been determined [9] (cf. figure 1) and the dimension of the disk-shaped aggregates have recently been measured from freeze-fracture experiments [10].

The determination of the cholesteric handedness, however, has been a major problem. Radley and Saupé have reported a method for determining handedness based on measurements of the sense of optical rotation [7]. However, the procedure contains some approximations and the measurements must be carried out on several samples of different thickness in order to minimize possible sign errors.

In the present study we report a simple determination of the cholesteric handedness based on measurements of the circular dichroism (CD) of a dye dissolved in the twisted phase. A parallel investigation of the handedness of the same sample was carried out using a new, independent spectroscopic technique: circular intensity differential scattering (CIDS). The results of the handedness determination are followed by a discussion on the mechanism of the cholesteric induction.

## 2. Handedness determination by dichroism techniques

The definition of helical handedness is often a source of confusion as different conventions are used in the literature. The convention used in this work is based on the following description. Looking along the helix axis, going away from the point of observation, the micelles are displaced by clockwise rotation for a right handed helix (cf. figure 2); i.e., the right handed helix sense is superimposable on the edge of a right handed screw in a conventional right handed coordinate frame.

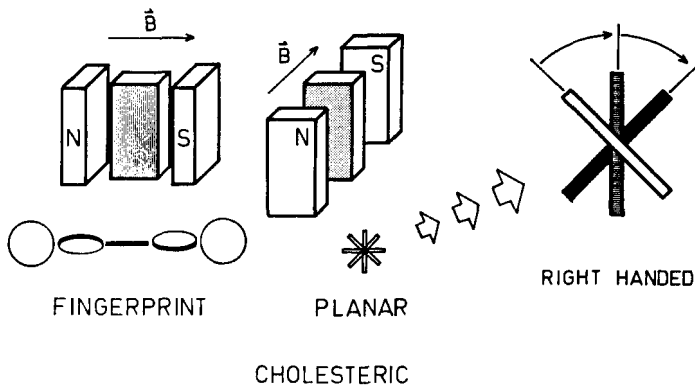

Figure 2. Magnetic orientations of a type II right handed cholesteric.

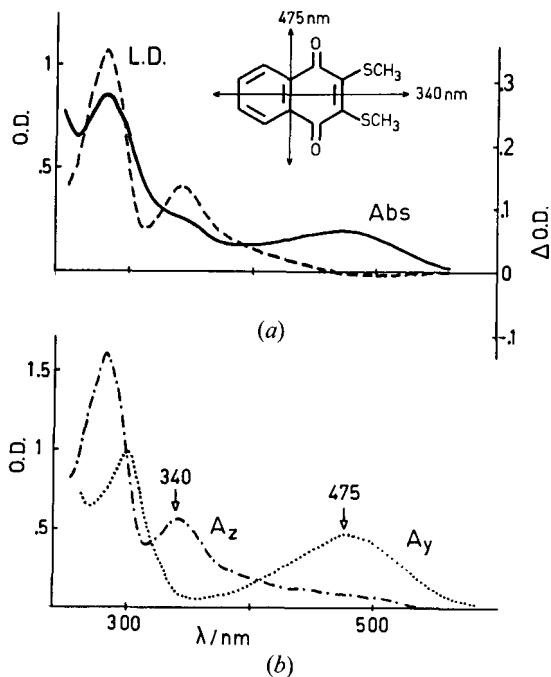

Figure 3. (a) Absorption and linear dichroism spectra of an oriented sample of the quinone dye dissolved in the thermotropic liquid crystal ZLI 1167 (recorded at 40°C). (b) Absorption components along the long (z) and short (y) molecular axes of the quinone.

The lyotropic solvent is transparent to U.V. radiation down to *c.* 200 nm and the electronic transition of the NH<sub>4</sub>Cl groups are not well characterized. In order to measure the chirality of the liquid crystal environment, we have chosen the dichroic dye, 2,3-dimethylthio-1,4-naphthoquinone as an optical probe. This substance shows two well-separated transitions at 340 and 475 nm. The former is polarized along the C<sub>2</sub> symmetry axis and the latter perpendicular to it (cf. figure 3).

The CD is related to the cholesteric handedness by the familiar equation [11],

$$(\text{OD}_L - \text{OD}_R)_j = P v_j^3 \Delta n (\text{OD}_\parallel - \text{OD}_\perp)_j / 2(v_j^2 - v_0^2). \quad (1)$$

Here (OD<sub>L</sub> - OD<sub>R</sub>)<sub>j</sub> is the CD at frequency *v<sub>j</sub>*, *v<sub>0</sub>* is the frequency of the selective reflection band (far I.R. for induced cholesteric lyomesophases), Δ*n* is the optical anisotropy (positive in our case), *P* is positive for a right handed helix and (OD<sub>∥</sub> - OD<sub>⊥</sub>)<sub>j</sub> is the linear dichroism of the helix building layers. The handedness of the lyotropic helical structure under investigation may be determined by this formula provided that the linear dichroism spectrum of the untwisted nematic solution is known.

The differential absorption of right and left circularly polarized light is measured along the helix and is determined by the stacking of linearly anisotropic micellar layers, which form a skewed helical array along the light path. The structure of each layer is that of an oriented bulk of the corresponding untwisted solution, i.e. doped by a solute in a racemic form.

The sample orientation required to collect the LD spectrum is achieved by putting the cell into a magnetic field perpendicular to the light path [12] (see figure 4). The negative diamagnetic anisotropy of this phase makes the two limiting orientations, (a) and (b), of the micelles equally favoured in a magnetic field (figure 4). But orientation (a) is stabilized also by the plates of the silica cell (1 mm path) and optical isotropy

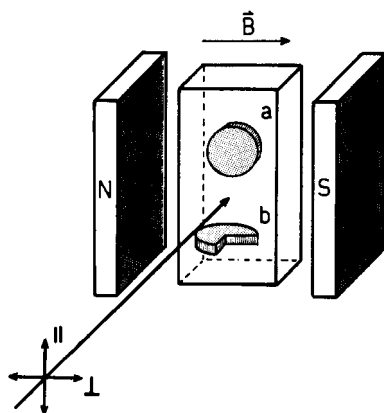

Figure 4. Sample orientation for recording linear dichroism spectrum in the nematic lyotropic solvent. Two limiting orientations of the micelles are shown.

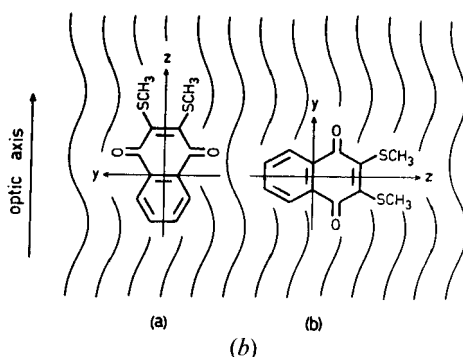
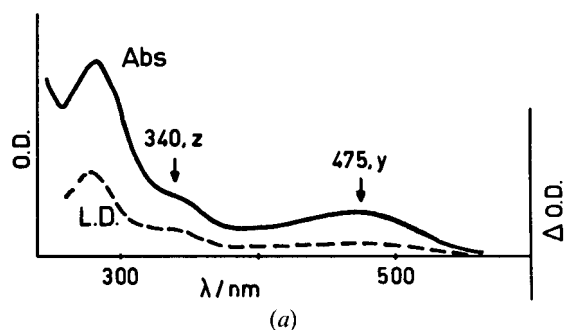

Figure 5. (a) Absorption and linear dichroism spectra of an oriented sample on the quinone dye dissolved in the nematic lyotropic mesophase. (b) Modes of intercalation of the dye within the micellar hydrocarbon chains.

along the light path is therefore induced by this surface effect. Any linear anisotropy left is due to the survival of (b)-like orientation.

The LD spectrum within the dye absorption region is reported in figure 5. It has a positive sign for either long or short axis polarization of the dye probe and its shape basically reproduces that of the isotropic absorption. This is due to a disk-like intercalation of the dye within each micellar bilayer [12], i.e. the  $z$  and  $y$  axes are equally aligned to the soap chains. The structural anisotropy of the solubilization site is obviously unable to discriminate between the orientations of the in plane  $y$  and  $z$

directions of the dye molecule. In consequence from equation (1), a positive CD spectrum is expected for a right handed induced cholesteric and on this basis, assignments are now possible.

CD spectra were measured with the cholesteric axis parallel to the light beam, i.e. in a planar texture. In all cases, pitch values must be longer than  $15\ \mu\text{m}$ . The planar texture was obtained by keeping the cell in an 8 kG magnet with the field perpendicular to the window for a few hours (see figure 2). Once obtained, the planar texture was stable for hours and the CD could easily be recorded on the sample out of the magnet.

The LD was recorded for each sample and in all cases the signal was extremely small. This indicates that the CD recorded was a real CD and not an artefact due to LD [13]. To this purpose, and with reference to a recent paper questioning the validity of CD measurements in oriented phases [14], we wish to note our previous experience with thermotropic cholesterics [15]. In this case, the helical handedness can be detected easily by two completely independent methods: CD spectra using equation (1) and the observation under the microscope of the handedness of the double spiral disclination lines which appear when the sample is placed between a glass plate and a plano-convex lens under circular boundary conditions. In all cases which we have studied, the two methods gave the same answer provided that the sample did not show relevant LD.

The CD spectra reported in figure 6 show that cholesterol and (S)-1-phenylethanol induce left and right handed cholesterics, respectively. This is straightforward for the long axis polarized bands at 340 nm, which are oppositely signed in the two cases. The same signs observed for the CD signals at 475 nm may be justified and fit the same conclusion. The shape of the CD spectra are in fact expected to be the same as that of the LD of figure 5. This may be inferred from equation (1)

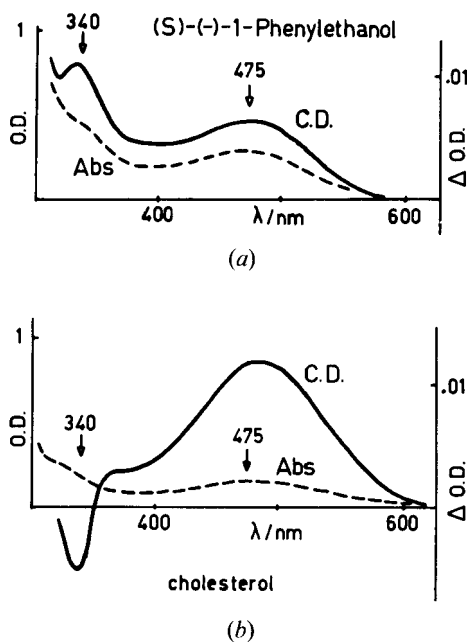

Figure 6. Absorption and circular dichroism spectra of the quinone dye dissolved in the lyotropic cholesteric induced (a) by (S)-(-)-1-phenylethanol and (b) by cholesterol.

The twisting powers of several chiral dopants in the DACl nematic and the relative signs of the circular dichroism induced in the absorption bands of the quinone dye.

| Compound                                      | CD <sub>λ</sub>   |                   | β/μm <sup>-1</sup> (e) |
|---|-------------------|-------------------|------------------------|
|   | CD <sub>340</sub> | CD <sub>475</sub> |                        |
| (R)-1,1'-Binaphthyl-2,2-diyhydrogen phosphate | (-)               | (-)               | -9                     |
| Calycanthine                                  | (-)               | (-)               | -4.1                   |
| Λ-Rh(pd) <sub>3</sub> (a)                     |                   | (c)               | -4                     |
| Λ-Cr(pd) <sub>3</sub> (a)                     |                   | (c)               | +3                     |
| Cholesterol                                   | (-)               | (+)               | -1.4 (f)               |
| Colchicin                                     | (d)               | (-)               | -1.4                   |
| (S)-(-)-1-Phenylethanol                       | (+)               | (+)               | +0.15 (g)              |
| D(-)-Tartaric acid                            | (-)               | (-)               | -0.05 (h)              |
| Λ-Co(en) <sub>3</sub> Cl <sub>3</sub> (b)     |                   |                   | 0.00                   |
| Glucose, saccharose                           |                   |                   | 0.00                   |

(a) pd = Pentandionate.

(b) en = Ethylendiamine.

(c) The weak bands of quinone are masked by the complex chromophore so the chirality is determined using the azo-dye Congo-Red and observing the CD of the band at 500 nm. In all cases studied, the use of Congo-Red leads to the same result as the use of dimethylthionaphthoquinone.

(d) The quinonic band at 340 nm is masked by the colchicine chromophore.

(e) β = (pcr)<sup>-1</sup> where *p* is the pitch in μm of the induced cholesteric, *c* is the concentration of the chiral dopant expressed, in the present paper, as moles of solute/moles of decylammonium chloride, and *r* is its optical purity. The sign + refers to a right handed cholesteric while the sign - refers to a left handed one.

(f) [7] reports β = -1.51 μm<sup>-1</sup> in the phase DACl/NH<sub>4</sub>Cl/water = 36.1/3.9/60.0 wt %.

(g) Both enantiomers were measured.

(h) [7] reports for (+)-tartaric acid β = +0.046 in the phase caesium decylsulphate/decanol/water = 39.7/4.8/55.5 wt %.

by taking into account the fact that the contribution of a solute absorption band, in the visible or U.V. region, to a change in the refractive index of a solute-solvent system is very small [16].

The CD spectrum induced by cholesterol shows, in contrast, a sign inversion on passing from the lowest energy *y* to the *z* polarized transition.

This may be explained by taking into account the well-known ability of cholesterol to stiffen the host soap chains [17], thus making the dye solubilization site able to discriminate between the *z* and *y* orientations. An (*a*)-like intercalation [12] (see figure 5) is thus induced; the basic rod-like shape of the dye is now recognized and only its *z* axis is preferentially aligned to the bilayer soap chains. The resulting negative LD of its *y* polarized transition causes sign inversion in the CD spectrum.

Helical characteristics for the chiral inducers investigated are reported in the table, together with their twisting powers (β). In particular, tartaric acid and cholesterol were also studied by Radley and Saupe [7]; their assignments of helical handedness are identical to ours. Our attributions rely on the theoretical treatment which led to equation (1). It is an extension of the Manguin model [18] which is certainly a rather crude one for a cholesteric liquid crystal, particularly if it is a lyotropic. The CIDS technique provides an independent method to check the validity of these CD assignments.

### 3. Handedness determination by CIDS

Circular intensity differential scattering (CIDS) is the property of chiral molecules or aggregates to scatter different amounts of incident right and left circularly polarized light to a given point in space. The CIDS is defined by

$$\text{CIDS}(\theta, \phi) = [I_L(\theta, \phi) - I_R(\theta, \phi)]/[I_L(\theta, \phi) + I_R(\theta, \phi)], \quad (2)$$

where  $I_L(\theta, \phi)$  and  $I_R(\theta, \phi)$  are the scattered intensities at a given direction in the radiation field for incident left and right circularly polarized light respectively.  $\theta$  and  $\phi$  are the polar and azimuthal angles which define the position of the detector with respect to the direction of the incident light. In a typical experiment, the scattering is measured only in a given plane; for this plane,  $\text{CIDS} = \text{CIDS}(\theta)$ .

Certain structural parameters of large chiral molecules and aggregates are manifested in the sign, magnitude and angular dependence of the CIDS signal [19]. This property of CIDS can be exploited to determine pitch lengths and handedness of aligned cholesteric liquid crystals [20–22]. This information can be obtained by measuring the experimental CIDS for a known orientation and then comparing it with calculated CIDS data for a well-characterized model. This has been done successfully for rotationally averaged samples [21] of certain long-range biological chiral structures as well as oriented cholesteric liquid crystals [20, 22].

In the CIDS experiment the polarization of the incident light is modulated to produce alternating right and left circular polarizations. The light scattered from the sample is detected as a function of the angle,  $\theta$ , about the scattering volume and passed to a lock-in analyser to obtain  $\{I_L(\theta) - I_R(\theta)\}$ . The DC portion of the detected signal is processed to provide  $\{I_L(\theta) + I_R(\theta)\}$  and in this way the  $\text{CIDS}(\theta)$  is obtained [23].

In the present investigation, the CIDS was measured for the cholesteric lyotropics induced by cholesterol and (S)-1-phenylethanol, which were assigned to be left and right handed respectively, on the basis of our CD measurements. The samples were aligned in a magnetic field to produce planar or fingerprint orientations (see figure 2). Although both orientations provided good CIDS data, only those for the planar orientation will be discussed in determining the handedness of the samples. The fingerprint system is somewhat more difficult to model and so for simplicity is left out. Therefore, in the following discussion the beam is always incident along the helical axis formed by the twisted lyotropic system.

The CIDS spectra are reported in figures 7 and 8. The spectral interpretation in terms of sample handedness may be very straightforward when the pitch of the sample is near or equal to the wavelength of the incident light. In this case, a right handed structure selectively reflects a right handed circularly polarized beam. We should expect therefore to see a positive CIDS near  $\theta = 0^\circ$  (see equation (2)) for a right handed helix and the opposite for a left handed structure [20, 22]. In our case, the pitch/wavelength ratio is about 200 and the sign of the CIDS near  $\theta = 0^\circ$  is hard to predict *a priori*. In order to determine the handedness from these experimental data, a CIDS computer simulation based on a model with a predefined handedness was used. A very simple model was constructed, namely a twisted ladder composed of uniaxially polarizable groups placed along the  $z$  optical axis (see figure 9)). The groups, or local directors, are oriented so that they twist from one boundary to the next and the sense of twist is defined in a right handed frame and is consistent with the convection defined previously (cf. figure 9). The polarization of the light is defined such that the spatial distribution of the electric field follows a right handed helix for right circular



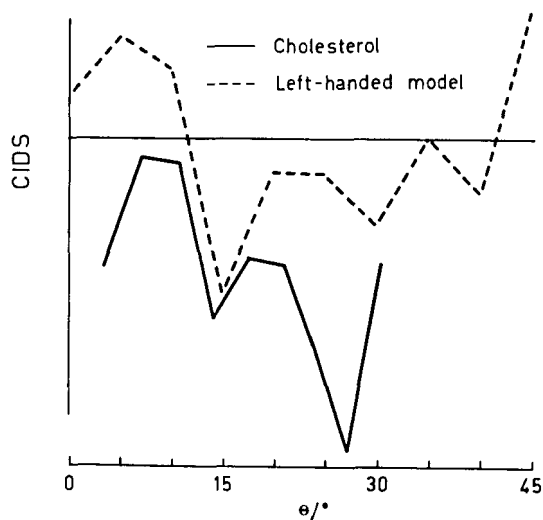

Figure 7. Circular intensity differential scattering spectrum (in arbitrary units) of a lyotropic cholesteric induced by cholesterol (—). Calculated spectrum for a left handed model (---).

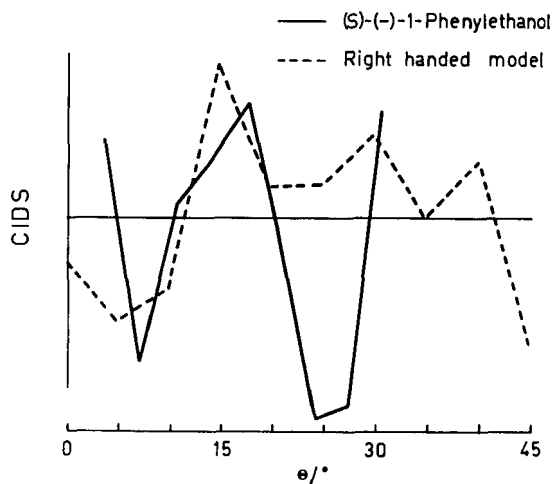

Figure 8. Circular intensity differential scattering spectrum (in arbitrary units) of a lyotropic cholesteric induced by (S)-(-)-1-phenylethanol (—). Calculated spectrum for a right handed model (---).

polarization. The left circularly polarized field then follows a left handed helical sense. The expression for the right and left circular polarization unit vectors are

$$\hat{\epsilon}_R = (\hat{x} - i\hat{y})/\sqrt{2}, \quad \hat{\epsilon}_L = (\hat{x} + i\hat{y})/\sqrt{2}. \quad (3)$$

In this way, a CIDS pattern may be computed for the model, whose structural parameters are indicative of the sample helicity. The CIDS calculations are performed within the frame of classical electrodynamics and use polarizability tensors to describe the scattering groups.

When the incident light interacts with the charges in the scatterers through its electric vector, oscillating dipoles are induced. These dipoles re-emit the light,

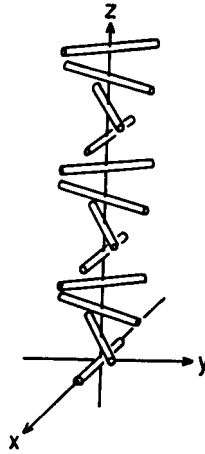

Figure 9. The right handed twisted ladder of uniaxiaally polarizable groups, used as a theoretical model.

maintaining a well-defined phase relationship which gives rise to interference phenomena. The CIDS angular dependence is the result of the interference of the polarized electromagnetic fields travelling outward, from their dipolar sources. This interference pattern is different for incident right and left circularly polarized light if the dipoles induced are arranged in a chiral fashion. The field anywhere in the scattering volume  $\mathbf{E}(\mathbf{x})$  is therefore treated as the superposition of the incident electric field  $\mathbf{E}_0(\mathbf{x})$  and the sum of the fields produced by the oscillating dipoles within the scatterer (the secondary field) originating from all the groups in the system [24]. The internal field may be described as

$$\mathbf{E}(\mathbf{x}) = \mathbf{E}_0(\mathbf{x}) + 4\pi k^2 \int \Gamma(\mathbf{x}, \mathbf{x}') \cdot \boldsymbol{\alpha}(\mathbf{x}') \cdot \mathbf{E}(\mathbf{x}') d^3x', \quad (4)$$

where  $\mathbf{E}_0(\mathbf{x})$  is the incident field,  $\Gamma(\mathbf{x}, \mathbf{x}')$  is a Green's function tensor which relates  $\mathbf{E}(\mathbf{x}')$ , the field at  $\mathbf{x}'$ , with that at position  $\mathbf{x}$ .  $\boldsymbol{\alpha}(\mathbf{x}')$  is a polarizability tensor that determines the reponse of a group to the incident and internal field.

At points of observation very far from the sample, the scattered electric field is a radiating spherical wave. Therefore, in the far field approximation and for uniaxial polarizabilities

$$\boldsymbol{\alpha}_i = \alpha \hat{e}_i \hat{e}_i^*,$$

the scattered field takes the form [24]

$$\mathbf{E}_{\text{scatt}} = E_0 k^2 (\exp(ikr)/r) (\mathbf{I} - \hat{k}\hat{k}) \sum_{i=1}^n \sum_{j=1}^n [\exp\{i(k_0 \cdot \mathbf{x}_j - \mathbf{k} \cdot \mathbf{x}_i)\} A_{ij}^{-1} (\hat{e}_j^* \hat{e}_0) \hat{e}_i], \quad (5)$$

where  $k$  is  $2\pi/\lambda$  and  $(\mathbf{I} - \hat{k}\hat{k})$  is a projection operator that maintains the transversality propriety of the scattered wave, i.e. only tangential components of the spherical waves are allowed. The scattered field has radial components only near the dipole [19]. The distance from the scattering volume to the detector is  $r$ ,  $\mathbf{k}_0$  is the incident wavevector and  $\mathbf{k}$  is the scattered wavevector.  $\mathbf{x}_i$  and  $\mathbf{x}_j$  are the positions of the  $i$ th and  $j$ th group respectively. The terms  $\hat{e}_i$  and  $\hat{e}_j$  are polarizability unit vectors for the  $i$ th and  $j$ th

groups. The matrix  $A_{ij}$  is a function of  $\Gamma(\mathbf{x}_i, \mathbf{x}_j)$  which accounts for the coupling between pairs of groups in the system. The number of scattering groups in the system determines the dimension of  $A$ . The incident polarization is given by  $\varepsilon$  which corresponds to  $\hat{\varepsilon}_R$  or  $\hat{\varepsilon}_L$  as in equation (3). The intensity for  $I_L$  and  $I_R$  may thus be computed as  $E_L E_L^*$  and  $E_R E_R^*$ .

It must be pointed out that this theoretical treatment is carried out within the so-called infinite Born approximation. Liquid crystals are relatively dense media and the coupling interactions between the building groups in the sample must be taken into account in the calculation. The first Born approximation, which excludes these interactions, cannot be used; in contrast the infinite Born approximation allows all orders of interaction among the polarizable groups. This method describes the local field at any point in the system and therefore accounts for the effects of sample density and path length on the polarization evolution through the material.

The results of the model calculations are presented in figures 7 and 8. As mentioned previously, the model geometry consisted of twisted uniaxial polarizabilities placed along the optical axis. The pitch for all of the models was + or  $-100 \mu\text{m}$ , the minus sign indicating a left handed helix. The path length was fixed at  $200 \mu\text{m}$  to match the experimental conditions. The magnitude of the polarizability was arbitrarily set to  $10\,000 \mu\text{m}^3$ . The wavelength of the incident light, as seen by the sample, was 350 nm. This was obtained by correcting the 488 nm laser light for the refractive index of the sample. The scattering was calculated between  $\theta = 0^\circ$  and  $45^\circ$  in order to scale it with the experimental data. As expected, the results show mirror image CIDS patterns for the two enantiomeric models. The fitting of the computed and the experimental CIDS patterns is reasonably good. The CIDS of the cholesterol solution is shifted toward the negative scale but reproduces well the sequence of peaks centred at  $5^\circ$ ,  $15^\circ$  and  $30^\circ$ , computed for a left handed model (see figure 7). The CIDS of the lyotropic doped with (S)-1-phenylethanol reproduces the first two peaks of the right handed model for the forward section, from  $\theta = 0^\circ$  to  $20^\circ$ , thus confirming the CD assignment. Our confidence in this determination is relatively high since the model pitch, path length and incident (corrected) wavelength all match the actual experimental parameters. The calculated CIDS appears sensitive to a change in any of these parameters. Small deviations of pitch, path length or wavelength produce significant differences between the experimental and calculated results. In addition, the CIDS calculations are able to display the proper selective resonance reflection property when the pitch matches the wavelength of the incident light.

Deviations between the experimental and calculated data may be accounted for by the following reasons: the orientational fluctuations in the directors were not simulated, but the off-angle scattering was nevertheless obtained in the calculations by repeating the unit cell only along the optical axis; the spacing between groups in the model was 285 nm which was probably not close enough to avoid diffraction between groups and does not account for the actual distance between pairs of closest micelles. This model limitation is not serious; it is expected to influence mostly the description of the group interactions which would affect the calculations, however the chirality properties of the system were reproduced well enough to make an assignment of handedness. In addition biaxial instead of uniaxial polarizability would have given a more realistic picture of these interactions, but computer time and memory are the limiting factors for both cases.

The experimental data may be strongly affected by non-homogeneous sample orientations and by the fluidity of the sample. During the experiments, the light

scattering fluctuated slowly over time, indicating a fluidity of the long range structure even though the microscope texture did not appear to change significantly over the same time period.

The fact that the experimental plots of the opposite handed helices are not exact mirror images of each other is not surprising. The reason for this is that the two oppositely handed helices are in fact not enantiomeric, because of the different chemical constitutions and effects of the chiral dopants (*vide infra*). The light scattering experiments were carried out without prior knowledge of the structures and the two samples were assumed to be enantiomeric, and hence the calculations showed enantiomeric (mirror image) behaviour. The opposite handedness of the two samples was, however, clearly displayed by the light scattering data.

#### 4. Mechanism of the cholesteric induction

The helical twisting power is an expression of the ability of a chiral solute to twist the nematic phase. Inspection of the data reported in the table indicates several points.

A first observation is that saccharose, glucose and the charged metal complex  $\Delta$ -Co(en) Cl, which are almost certainly in the aqueous phase, do not show any appreciable twist. Conversely, the zero charge complex  $\Lambda$ -Rh(pd)<sub>3</sub>, which has a geometry similar to that of the charged complex but is soluble in organic solvents, displays a rather high value of  $\beta$ . The highest values of  $\beta$  are shown by binaphthyls and calycanthine. These molecules are soluble in the organic phase and contain two aromatic groups chirally distorted in relation to each other in a fixed conformation. This behaviour is similar to what has been observed in thermotropic liquid crystals [2] and the correlations between the structure of the dopant and the twisting power deduced for thermotropics [2] can be extended to lyotropic nematics.

We have tried to measure the CD spectra of the quinone dye in cholesterics having a relatively short pitch (*c.* 8–12  $\mu$ m) but, even leaving the sample in the magnetic field for a few days, the intensity of the CD was very small (about two orders of magnitude smaller than for pitches of *c.* 50–200  $\mu$ m which were usually employed for CD measurements). On the other hand, no good planar textures could be observed under the microscope in these samples. This fact could be explained if the distortion of the micelle is considered; at relatively high concentrations of dopants displaying high twisting powers, the distortion becomes non-negligible and changes in the direction of the magnetic anisotropy of the individual micelle are likely to occur. This fact, together with the observation about the relationships between molecular structure and solubility, support the view that the mechanism of formation of cholesterics in lyotropic nematics is likely to be via distorted micelles [25].

At the supramolecular level the mechanism of cholesteric induction is similar to that proposed for thermotropic nematics at the molecular level, where the mechanism of induction is connected to the stabilization of chiral conformations in the molecules of the liquid crystal.

#### 5. Experimental section

The dichroic dye 2,3-dimethylthio-1,4-naphthoquinone was synthesized as described in [26].

Cholesteric samples were prepared by stirring magnetically for *c.* 12 hours the appropriate mixture of DACl, ammonium chloride, water (36.1, 3.9, 60.0 wt %) and the chiral dopant with or without the dye.

Orientation was achieved as described in [12]. The pitches of the two samples used for the CIDS study were both  $100\ \mu\text{m}$  as determined by a microscopic method [7].

LD and CD spectra were recorded with a JASCO-J500 A dichrograph with an LD attachment. The LD evaluation technique and spectra deconvolution are reported in [27].

The CIDS measurements were carried out with a polarized light scattering instrument built at the University of New Mexico [23]. For the CIDS experiments, the samples were placed in a  $200\ \mu\text{m}$  path length fused silica cell (NSG Precision Cell, Inc., 20-H-0.2) and then oriented in a 10 kG magnet for 6 to 12 hours to obtain the planar orientation. The cell was transferred into the CIDS instrument and the measurements were carried out in the front scattering angles region between  $\theta = 5^\circ$  and  $45^\circ$  and repeated until the measurements became irreproducible, indicating the slow process of disalignment. The sample was then placed back in the magnet and aligned for another measurement. This process was repeated several times in order to average the data. The actual scattering angles of the sample volume were between about  $\theta = 3^\circ$  and  $31^\circ$  after accounting for the sample/air refractive interface. The total intensity in the back angles  $\pm 15^\circ$  from  $180^\circ$  was too low to gather data for analysis. All measurements were performed using the 488 nm line of an argon laser. A temperature controlled refractometer (Bausch and Lomb ABBE-3L) was used to obtain the sample refractive indices to correct for scattering angles and the wavelength inside the sample. The index of refraction was determined to be 1.39 for both samples.

The CIDS instrument baseline was calibrated to values less than  $1/10\,000$  so that instrument error due to imperfect circular polarizations would be negligible [21].

We wish to dedicate this paper to Professor S. F. Mason on the occasion of his 65th birthday.

### References

- [1] GOTTARELLI, G., HIBERT, M., SAMORI', B., SOLLADIE', G., SPADA, G. P., and ZIMMERMANN, R., 1983, *J. Am. chem. Soc.*, **104**, 7318. GOTTARELLI, G., SPADA, G. P., SENO, K., HAGISHITA, S., and KURIYAMA, K., 1986, *Bull. chem. Soc. Japan*, **59**, 1607. GOTTARELLI, G., SPADA, G. P., BARTSCH, R., SOLLADIE', G., and ZIMMERMANN, R., 1986, *J. org. Chem.*, **51**, 589. GOTTARELLI, G., HANSEN, H.-J., SPADA, G. P., and WEBER, R. H., 1987, *Helv. chim. Acta*, **70**, 430.
- [2] GOTTARELLI, G., and SPADA, G. P., 1985, *Molec. Crystals liq. Crystals.*, **123**, 377. GOTTARELLI, G., SPADA, G. P., VARECH, D., and JACQUES, J., 1986, *Liq. Crystals* **1**, 29.
- [3] PENOT, J. P., JACQUES, J., and BILLARD, J., 1968, *Tetrahedron Lett.*, p. 4013. KORTE, E. H., 1978, *Appl. Spectrosc.*, **32**, 568. BERTOCCHI, G., GOTTARELLI, G., and PRATI, R., 1984, *Talanta*, **31**, 138.
- [4] GOTTARELLI, G., SAMORI', B., FUGANTI, C., and GRASSELLI, P., 1981, *J. Am. chem. Soc.*, **103**, 471.
- [5] LAWSON, K. D., and FLAUTT, T. J., 1967, *J. Am. chem. Soc.*, **89**, 5490. FORREST, B. J., and REEVES, L. W., 1981, *Chem. Rev.*, **81**, 1.
- [6] HENDRIKX, Y., CHARVOLIN, J., RAWISO, M., LIEBERT, L., and HOLMES, M. C., 1983, *J. phys. Chem.*, **87**, 3991.
- [7] RADLEY, K., and SAUPE, A., 1978, *Molec. Phys.*, **35**, 1405.
- [8] CHEN, D. M., FUJIWARA, F. Y., and REEVES, L. W., 1977, *Can. J. Chem.*, **55**, 2396.
- [9] ALCANTARA, M. R., and VANIN, J. A., 1984, *Molec. Crystals liq. Crystals*, **107**, 333.
- [10] ZASADZINSKI, J. A. N., SAMMON, M. J., and KUZMA, M. R., 1986, *Proceedings of the 11th International Liquid Crystal Conference*, Berkeley, California, Abstracts, Lecture LY-01.
- [11] DUDLEY, R. J., MASON, S. F., and PEACOCK, R. D., 1975, *J. chem. Soc. Faraday Trans. II*, **71**, 997.

- [12] SAMORI', B., and MATTIVI, F., 1986, *J. Am. chem. Soc.*, **108**, 1679. LAURENT, M., and SAMORI', B., 1987, *J. Am. chem. Soc.*, **109**, 5109.
- [13] NORDEN, B., 1977, *J. chem. Phys.*, **81**, 151.
- [14] SHINDO, Y., and OHMI, Y., 1985, *J. Am. chem. Soc.*, **107**, 91.
- [15] GOTTARELLI, G., SAMORI', B., STREMMENOS, C., and TORRE, G., 1981, *Tetrahedron*, **37**, 395.
- [16] SAMORI', B., 1979, *J. phys. Chem.*, **83**, 375.
- [17] FUJIWARA, F. Y., REEVES, L. W., 1976, *J. Am. chem. Soc.*, **98**, 6790. DUFORC, E. J., PARISH, E. J., CHITRAKORN, S., and SMITH, C. P., 1984, *Biochemistry, N.Y.*, **23**, 6062.
- [18] MANGUIN, M. C., 1911, *Bull. Soc. fr. Minér.*, **34**, 71.
- [19] BUSTAMANTE, C., MAESTRE, M. F., and TINOCO, I., JR., 1980, *J. chem. phys.*, **73**, 4273; 1980, *Ibid.*, **73**, 6046; 1981, *Ibid.*, **74**, 4839; 1982, *Ibid.*, **76**, 3440.
- [20] BUSTAMANTE, C. F., WELLS, K. S., KELLER, D., SAMORI', B., MAESTRE, M. F., and TINOCO, I., JR., 1984, *Molec. Crystals liq. Crystals*, **111**, 79.
- [21] WELLS, K. S., BEACH, D. A., KELLER, D., and BUSTAMANTE, C., 1986, *Biopolymers*, **25**, 2043.
- [22] HALL, K., WELLS, K. S., KELLER, D., SAMORI', B., MAESTRE, M. F., TINOCO, I., JR., and BUSTAMANTE, C., 1985, *Applications of Circularly Polarized Radiation Using Synchrotron and Ordinary Sources*, edited by F. S. Allen and C. Bustamante (Plenum), pp. 77-93.
- [23] KATZ, J. E., WELLS, S., USSERY, D., BUSTAMANTE, C., and MAESTRE, M. F., 1984, *Rev. scient. Instrum.*, **55**, 1574.
- [24] KELLER, D., and BUSTAMANTE, C., 1986, *J. chem. Phys.*, **84**, 2961.
- [25] RADLEY, K., and TRACEY, A. S., 1985, *Can. J. Chem.*, **63**, 95. SAUPE, A., 1984, *Nuovo Cim.*, **3**, 16.
- [26] FIESER, L. F., and BROWN, L. H., 1949, *J. Am. chem. Soc.*, **71**, 3609.
- [27] SAMORI', B., 1983, *Molec. Crystals liq. Crystals*, **98**, 385. SAMORI', B., MARIANI, P., and SPADA, G. P., 1982, *J. chem. Soc. Perkin Trans. II*, p. 447.